



Intended to alert the user to the presence of uninsulated “dangerous voltage” within the product’s enclosure that may be of sufficient magnitude to constitute a risk of electric shock to persons.



Intended to alert the user of the presence of important operating and maintenance (servicing) instructions in the literature accompanying the product.

CAUTION: Risk of electrical shock — DO NOT OPEN!

CAUTION: To reduce the risk of electric shock, do not remove cover. No user serviceable parts inside. Refer servicing to qualified service personnel.

WARNING: To prevent electrical shock or fire hazard, do not expose this appliance to rain or moisture. Before using this appliance, read the operating guide for further warnings.



Este símbolo tiene el propósito, de alertar al usuario de la presencia de “(voltaje) peligroso” sin aislamiento dentro de la caja del producto y que puede tener una magnitud suficiente como para constituir riesgo de descarga eléctrica.



Este símbolo tiene el propósito de alertar al usuario de la presencia de instrucciones importantes sobre la operación y mantenimiento en la información que viene con el producto.

PRECAUCION: Riesgo de descarga eléctrica ¡NO ABRIR!

PRECAUCION: Para disminuir el riesgo de descarga eléctrica, no abra la cubierta. No hay piezas útiles dentro. Deje todo mantenimiento en manos del personal técnico cualificado.

ADVERTENCIA: Para evitar descargas eléctricas o peligro de incendio, no deje expuesto a la lluvia o humedad este aparato. Antes de usar este aparato, lea más advertencias en la guía de operación.



Ce symbole est utilisé dans ce manuel pour indiquer à l'utilisateur la présence d'une tension dangereuse pouvant être d'amplitude suffisante pour constituer un risque de choc électrique.



Ce symbole est utilisé dans ce manuel pour indiquer à l'utilisateur qu'il ou qu'elle trouvera d'importantes instructions concernant l'utilisation et l'entretien de l'appareil dans le paragraphe signalé.

ATTENTION: Risques de choc électrique — NE PAS OUVRIR!

ATTENTION: Afin de réduire le risque de choc électrique, ne pas enlever le couvercle. Il ne se trouve à l'intérieur aucune pièce pouvant être réparée par l'utilisateur. Confiez l'entretien et la réparation de l'appareil à un réparateur Peavey agréé.

AVERTISSEMENT: Afin de prévenir les risques de décharge électrique ou de feu, n'exposez pas cet appareil à la pluie ou à l'humidité. Avant d'utiliser cet appareil, lisez attentivement les avertissements supplémentaires de ce manuel.



Dieses Symbol soll den Anwender vor unisolierten gefährlichen Spannungen innerhalb des Gehäuses warnen, die von Ausreichender Stärke sind, um einen elektrischen Schlag verursachen zu können.



Dieses Symbol soll den Benutzer auf wichtige Instruktionen in der Bedienungsanleitung aufmerksam machen, die Handhabung und Wartung des Produkts betreffen.

VORSICHT: Risiko — Elektrischer Schlag! Nicht öffnen!

VORSICHT: Um das Risiko eines elektrischen Schlages zu vermeiden, nicht die Abdeckung entfernen. Es befinden sich keine Teile darin, die vom Anwender repariert werden könnten. Reparaturen nur von qualifiziertem Fachpersonal durchführen lassen.

ACHTUNG: Um einen elektrischen Schlag oder Feuergefahr zu vermeiden, sollte dieses Gerät nicht dem Regen oder Feuchtigkeit ausgesetzt werden. Vor Inbetriebnahme unbedingt die Bedienungsanleitung lesen.

IMPORTANT SAFETY INSTRUCTIONS

WARNING: When using electrical products, basic cautions should always be followed, including the following:

1. Read these instructions.
2. Keep these instructions.
3. Heed all warnings.
4. Follow all instructions.
5. Do not use this apparatus near water.
6. Clean only with a dry cloth.
7. Do not block any of the ventilation openings. Install in accordance with manufacturer's instructions.
8. Do not install near any heat sources such as radiators, heat registers, stoves or other apparatus (including amplifiers) that produce heat.
9. Do not defeat the safety purpose of the polarized or grounding-type plug. A polarized plug has two blades with one wider than the other. A grounding type plug has two blades and a third grounding plug. The wide blade or third prong is provided for your safety. If the provided plug does not fit into your outlet, consult an electrician for replacement of the obsolete outlet.
10. Protect the power cord from being walked on or pinched, particularly at plugs, convenience receptacles, and the point they exit from the apparatus.
11. Only use attachments/accessories provided by the manufacturer.
12. Use only with a cart, stand, tripod, bracket, or table specified by the manufacturer or sold with the apparatus. When a cart is used, use caution when moving the cart/apparatus combination to avoid injury from tip-over.
13. Unplug this apparatus during lightning storms or when unused for long periods of time.
14. Refer all servicing to qualified service personnel. Servicing is required when the apparatus has been damaged in any way, such as power-supply cord or plug is damaged, liquid has been spilled or objects have fallen into the apparatus, the apparatus has been exposed to rain or moisture, does not operate normally, or has been dropped.
15. Never break off the ground pin. Write for our free booklet "Shock Hazard and Grounding." Connect only to a power supply of the type marked on the unit adjacent to the power supply cord.
16. If this product is to be mounted in an equipment rack, rear support should be provided.
17. Exposure to extremely high noise levels may cause a permanent hearing loss. Individuals vary considerably in susceptibility to noise-induced hearing loss, but nearly everyone will lose some hearing if exposed to sufficiently intense noise for a sufficient time. The U.S. Government's Occupational and Health Administration (OSHA) has specified the following permissible noise level exposures:

Duration Per Day In Hours	Sound Level dBA, Slow Response
8	90
6	92
4	95
3	97
2	100
1 1/2	102
1	105
1/2	110
1/4 or less	115

According to OSHA, any exposure in excess of the above permissible limits could result in some hearing loss. Ear plugs or protectors to the ear canals or over the ears must be worn when operating this amplification system in order to prevent a permanent hearing loss, if exposure is in excess of the limits as set forth above. To ensure against potentially dangerous exposure to high sound pressure levels, it is recommended that all persons exposed to equipment capable of producing high sound pressure levels such as this amplification system be protected by hearing protectors while this unit is in operation.

SAVE THESE INSTRUCTIONS!

ENGLISH

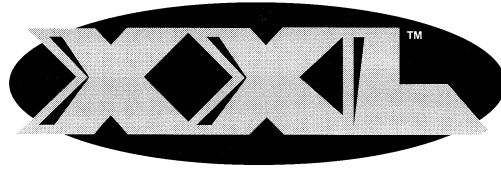

Big features....big sound. The XXL is the culmination of nearly a decade of refinements and tweaks to Peavey's innovative TransTube® vacuum tube emulation circuitry. The result is a monster of an amplifier capable of accurately reproducing tons and tons of the hottest tube amp tones imaginable....past and present. Three fully independent channels (clean/passive EQ, lead/passive EQ, and ultra/active EQ) give you a sonic palette that lets your imagination run wild. From the sparkling clean tones of the "vintage" mode to the nearly uncontrollable scream of the "ultra" mode to the extreme flexibility of new TransTube power amp damping and power level switches, the XXL is sure to leave you mesmerized every time you plug in. Capable of over 100 Watts of earth shaking power, into any standard guitar cabinet, this behemoth can blow the roof off the largest of venues or....with a twist of the master volume and a flip of the 25/50/100 Watt power level switch, keep a crowd in the smallest of bars. Further tonal mayhem can be accomplished with outboard effects via the footswitchable effects loop. Reverb is also included to put the icing on the cake. We've even thrown in a free footswitch and a classic jeweled pilot light so that you will certainly have the tools to break ALL of the rules. The all new Peavey XXL....now you don't have anymore excuses.

FEATURES

- Three fully independent channels
- Bottom, body, and edge active EQ on ultra channel
- Three-band passive EQ on clean and lead channels
- Three-position EQ and gain voicing switches on each channel
- 100 W (RMS) into 4, 8, or 16 Ohms (selectable impedance)
- Power level switch for 25 W, 50 W, or 100 W operation
- Power amp damping switch (tight, medium, loose)
- Footswitchable effects loop with effects level switch
- Preamp out / power amp In patching jacks
- Reverb
- Master volume
- Three-button footswitch included
- Classic jeweled pilot light
- Chrome-plated brass control knobs

Front Panel

(1) POWER SWITCH

This heavy-duty, two-way toggle switch applies mains power to the unit. The red POWER STATUS LAMP (2) will illuminate when this switch is in the ON position.

(2) POWER STATUS LAMP

This indicator illuminates when mains power is being supplied to the amp.

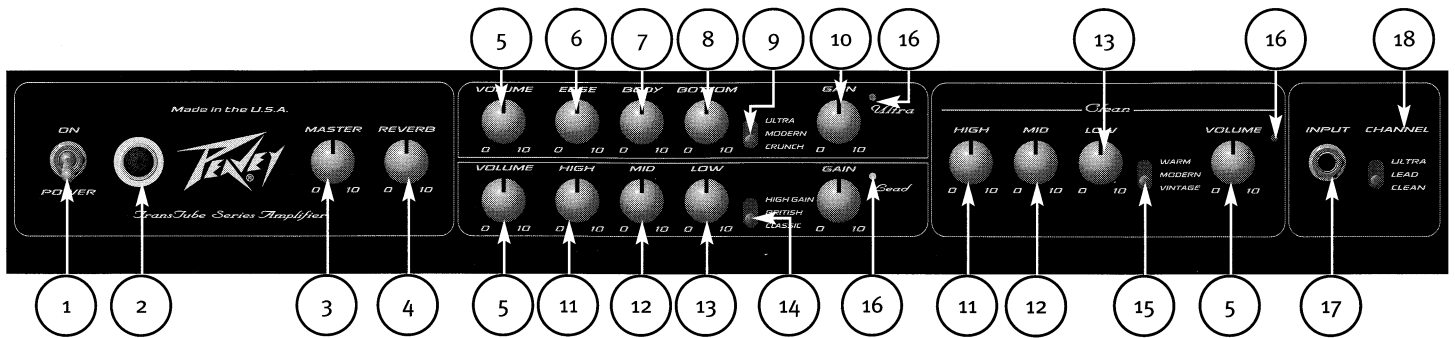

(3) MASTER VOLUME

This control sets the overall volume level of the amp. Once the desired balance between the three channels in the amplifier has been achieved, the entire output level of the unit can be increased or decreased by rotating this control. Clockwise rotation increases level; counterclockwise rotation decreases level.

(4) REVERB

Controls the overall reverb level.

(5) VOLUME

This control, on all three channels, sets the overall level of its respective channel.

(6) EDGE

This control, on the Ultra channel, varies the high frequency response of the amplifier. It is an active control (shelving type) and allows 15 dB of boost or cut.

(7) BODY

This control, on the Ultra channel, varies the mid frequency response of the amplifier. It is an active control (peak/notch type) and allows 15 dB of boost or cut.

(8) BOTTOM

This control, on the Ultra channel, varies the low frequency response of the amplifier. It is an active control (shelving type) and allows 15 dB of boost or cut.

(9) ULTRA / MODERN / CRUNCH

This three-position switch selects between three distinct gain and EQ voicings on the Ultra channel.

- (10) **GAIN**
This control, on both the Ultra and Lead channels, controls the input volume level of its respective channel. Rotating this control clockwise will increase the amount of preamp distortion and sustain.
- (11) **HIGH**
This passive control, on both the Clean and Lead channels, regulates the high frequency response of its respective channel.
- (12) **MID**
This passive control, on both the Clean and Lead channels, regulates the mid frequency response of its respective channel.
- (13) **LOW**
This passive control, on both the Clean and Lead channels, regulates the low frequency response of its respective channel.
- (14) **HIGH GAIN / BRITISH / CLASSIC**
This three-position switch selects between three distinct EQ and gain voicings on the Lead channel.
- (15) **WARM / MODERN / VINTAGE**
This three-position switch selects between three distinct EQ voicings on the Clean channel.
- (16) **CHANNEL ACTIVATION LEDs**
These indicators signify which channel is active. Ultra channel activation illuminates the red LED. Lead channel activation illuminates the yellow LED, and Clean channel activation illuminates the green LED.
- (17) **INPUT**
This 1/4" jack is designed to accommodate signals from any standard electric guitar.
- (18) **CHANNEL**
This three-position toggle allows selection between the XXL's three channels. CHANNEL ACTIVATION LEDs (16) indicate which channel is active. Channel switching can also be accomplished from the included footswitch. See the FOOTSWITCH section of this manual for explanation of switch operation. The CHANNEL switch must be set in the ULTRA position in order for the footswitch to operate properly.

Rear Panel

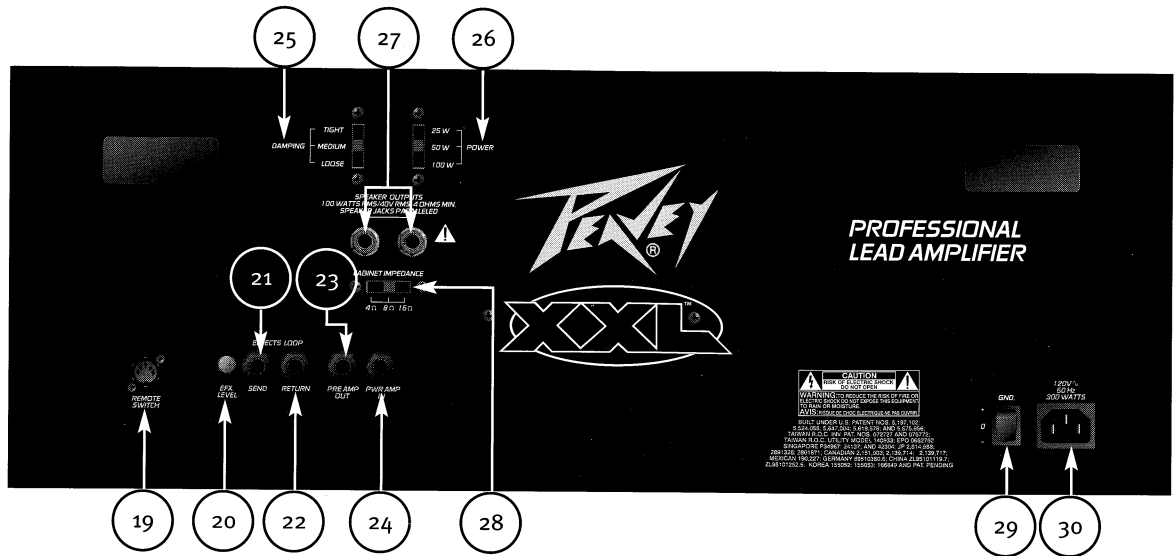

- (19) **REMOTE SWITCH**
This seven-pin DIN connector is provided for connection of the footswitch. The footswitch cable should be connected before the amp is powered up. See the FOOTSWITCH section of this manual for explanation of footswitch operation.
- (20) **EFFECTS LEVEL SWITCH**
Selects the effects loop operating level: -10 dBV (0.3V RMS) when “out” and 0 dBV (1 V RMS) when “in”.
- (21) **EFFECTS SEND**
Output for supplying signals to external low-level effects or signal processing equipment.
- (22) **EFFECTS RETURN**
Input for returning signals from external low-level effects or signal processing equipment.
- (23) **PREAMP OUT**
The preamp out can be used to route the amplified signal from the preamp to a mixing console, tape recorder, etc. Connect the preamp output to line-level inputs of other equipment using high quality shielded cable. This patch does not affect operation of the amplifier.
- (24) **POWER AMP IN**
Used to connect line-level signals to the XXL’s power amplifier section. Connect the power amp input to line-level output of other equipment using high quality shielded cable. This patch disconnects the XXL preamp section from the power amp section.
- (25) **DAMPING**
This three-position switch allows for adjustment of the damping factor of the power amplifier. Damping is the ability of an amplifier to control speaker cone motion after the signal disappears. A higher damping factor (TIGHT) reduces cone vibration more quickly than a lower damping factor (LOOSE). This switch works much like the Resonance and Presence controls found on other Peavey amps, if they were to be turned simultaneously. If the Damping switch is changed, the volume level of the amp will also change and may require re-adjustment of the Master Volume (3).

(26) **POWER**

This three-position switch selects the power output level of the power amplifier. This switch works like the T. Dynamics® control found on other Peavey amplifiers which provides for a more pronounced tube power compression simulation at lower settings.



(27) **SPEAKER OUTPUTS**

These paralleled 1/4" mono (TS) jacks are provided for the connection of speaker enclosure(s). Minimum speaker impedance is 4 Ohms. The CABINET IMPEDANCE switch (28) must be set to match the load of the speaker cabinet(s).

(28) **CABINET IMPEDANCE**

This three-position switch allows for appropriate selection of speaker cabinet impedance. If two enclosures of equal impedance are used, the switch should be set to half the individual value. For example, two 16 Ohm enclosures necessitate an 8 Ohm setting, while two 8 Ohm enclosures would require a 4 Ohm setting. Minimum speaker impedance is 4 Ohms.



(29) **GROUND POLARITY SWITCH**

This three-position rocker switch should normally be placed in the center (o) position. If hum or noise is noticed coming from the speaker enclosure(s), the switch may be placed in the “+” or “-” position to minimize hum and noise. If changing the polarity does not alleviate the problem, consult your authorized Peavey dealer, the Peavey factory, or a qualified service technician.



(30) **IEC MAINS CONNECTOR**

This is a standard IEC power connector. An AC mains cord having the appropriate AC plug and ratings for the intended operating voltage is included in the carton. The mains cord should be connected to the amplifier before connecting to a suitable AC outlet.

U.S. DOMESTIC AC MAINS CORD

The mains cord supplied with the unit is a heavy-duty, three-conductor type with a conventional 120 VAC plug with ground pin. If the outlet used does not have a ground pin, a suitable grounding adapter should be used, and the third wire should be grounded properly.

Never break off the ground pin on any equipment. It is provided for your safety.

NOTE: FOR UK ONLY

If the colors of the wires in the mains lead of this unit do not correspond with the colored markings identifying the terminals in your plug, proceed as follows: (1) The wire that is colored green and yellow must be connected to the terminal that is marked by the letter E, the earth symbol, colored green, or colored green and yellow. (2) The wire that is colored blue must be connected to the terminal that is marked with the letter N or the color black. (3) The wire that is colored brown must be connected to the terminal that is marked with the letter L or colored red.

Footswitch



- (31) **ULTRA / LEAD SELECTOR**
This switch selects between the Ultra and Lead channels of the amplifier. The red LED will illuminate when the Ultra channel is selected and the yellow LED will illuminate when the Lead channel is selected. The CLEAN SELECTOR (32) must be in BYPASS mode (green LED off) to activate either the Ultra or Lead channels.
- (32) **CLEAN SELECTOR**
This switch selects Clean channel and will activate regardless of the position of the ULTRA / LEAD SELECTOR (31). The green LED will illuminate when the Clean channel is selected. This switch must be in BYPASS mode (green LED off) in order to utilize the ULTRA / LEAD SELECTOR (31).
- (33) **EFFECTS SELECTOR**
This switch activates the amplifier's effects loop (20-22). The adjacent LED will illuminate when the effects loop is active.

Note: The "Channel" switch (18) on the amplifier must be in the "Ultra" position for the footswitch to operate.

XXL SUGGESTED SETTINGS

“X-Man”: Damping = LOOSE, Power = 100 W, Bridge Humbucker

Master and Reverb as desired

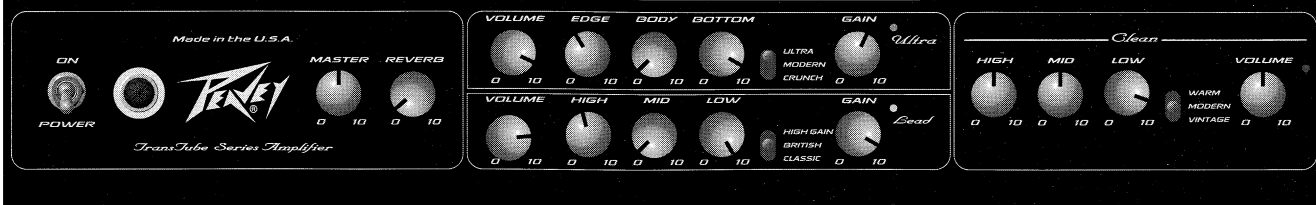

“Brown-o-tron”: Damping = MEDIUM, Power = 50 W, Humbucker

Master and Reverb as desired

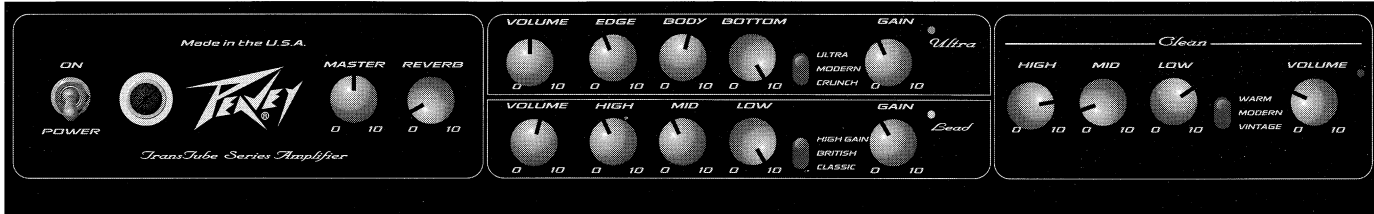

“Left Field”: Damping = TIGHT, Power = 25 W, Neck and Middle Single Coils

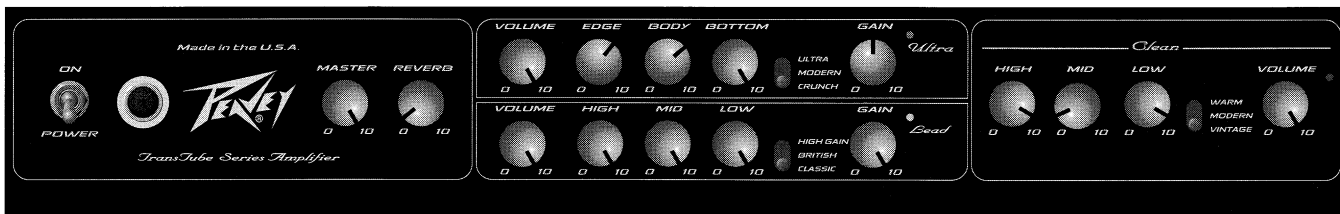

XXL Flow Chart

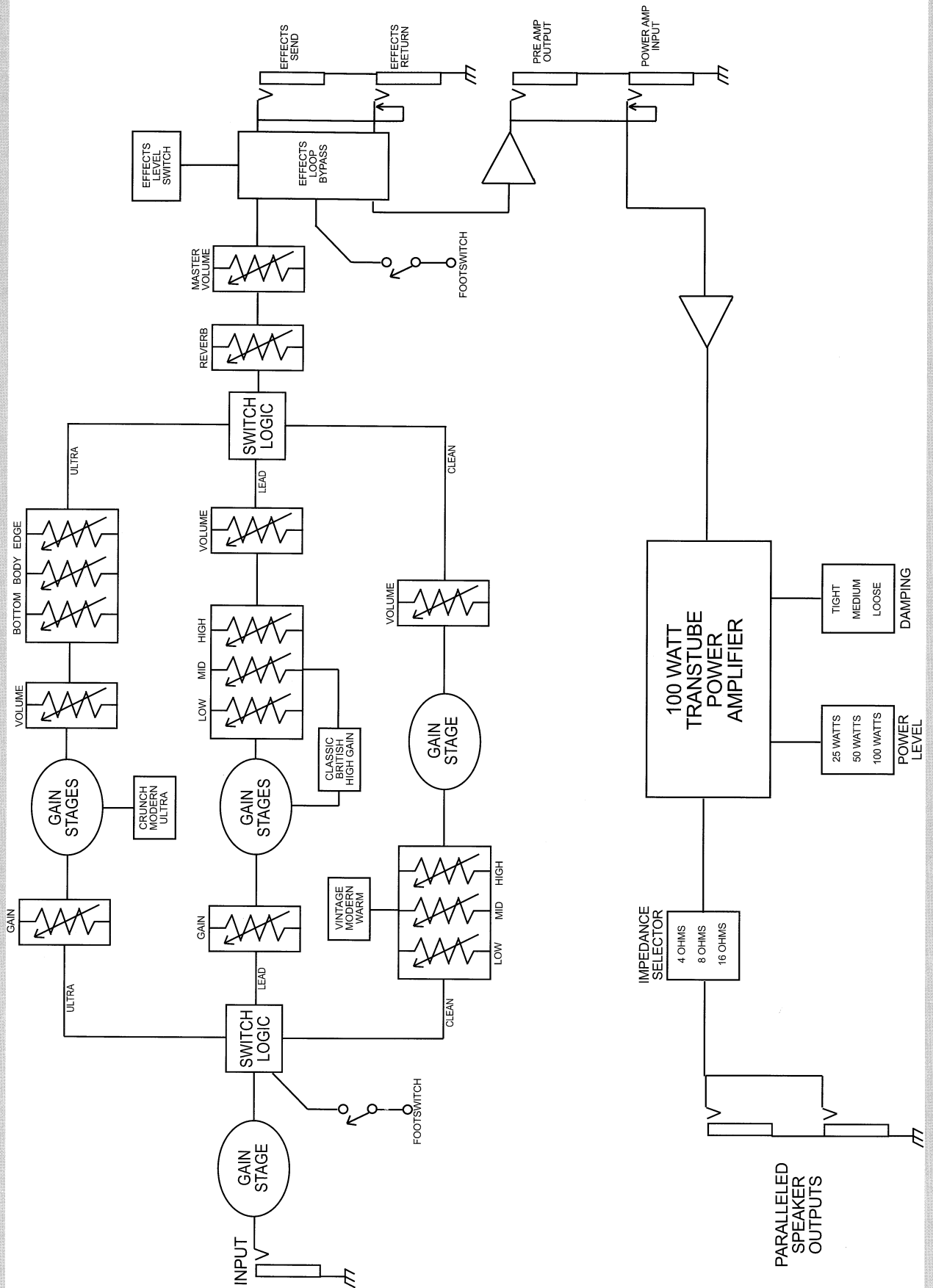

XXL SPECIFICATIONS

Power Amplifier Section:

Rated power and load:

100 W RMS into 16, 8, or 4 Ohms

Power at clipping:

(typically @ 5% THD, 1 kHz, 120 VAC line)
100 W RMS into 16, 8, or 4 Ohms

Frequency response:

+0 dB, -3 dB, 50 Hz to 38 kHz @ 60 W
RMS into 16 Ohms

Hum and noise:

Greater than 85 dB below rated power

Power consumption:

Domestic: 300 W, 60 Hz, 120 VAC
Export: 300 W, 50/60 Hz, 220-240 VAC

PREAMP SECTION:

The following specs are measured @
1 kHz with the controls preset as follows:

Low and High EQ @ 10, Mid EQ @ 0

Ultra and Lead Volumes @ 5

Bottom and Edge EQ @ 10

Body EQ @ 5

Master Volume @ 10

Reverb @ 0

Nominal Levels are with Gain/Clean

Volume @ 5

Minimum Levels are with Gain/Clean

Volume @ 10

Damping @ TIGHT

Power @ 100 W

Clean channel (vintage):

Nominal Input Level: -22.7 dB, 73 mV RMS

Minimum Input Level: -30.8 dB, 29 mV RMS

Maximum Input Level: -2.33 dB, 765 mV RMS

Lead channel (classic):

Nominal Input Level: -26.2 dB, 49 mV RMS

Minimum Input Level: -46.0 dB, 5 mV RMS

Ultra channel (ultra):

Nominal Input Level: -60 dB, 1 mV RMS

Minimum Input Level: -80 dB, 0.1 mV RMS

Effects send:

Load Impedance: 1 k Ohms or greater

Nominal Output Level:

Effects Level switch "out": -10.9 dBV,
285 mV RMS

Effects Level switch "in": -1.41 dBV,
850 mV RMS

Effects return:

Impedance: High Z, 22 k Ohms

Designed Input Level:

Effects Level switch "out": -10.9 dBV,
285 mV RMS

Effects Level switch "in": -1.41 dBV,
850 mV RMS

(Switching jack provides Effects Send to
Effects Return connection when not
used)

Preamp output:

Load Impedance: 1 k Ohms or greater

Nominal Output Level: -1.94 dBV,
800 mV RMS

input impedance - 18K ohms

Power amp input:

Impedance: High Z, 22 k Ohms

Designed Input Level: -1.94 dBV,
800 mV RMS

(Switching jack provides preamp output to
power amp input connection when not
used)

System hum and noise @ nominal input level:

(Clean channel, Modern, 20 Hz to 20 kHz
unweighted)

Greater than 72 dB below rated power

Equalization:

Clean and Lead channels:

Low, Mid, and High passive EQ with
three distinct voicings.

Ultra channel: Bottom, Body, and Edge
active EQ with 15 dB boost/cut on each
band.

Remote footswitch:

Special three-button unit with LED
indicators (included)

Dimensions:

11.0" H x 26.5" W x 11.0" D

279 mm H x 673 mm W x 279 mm D

Weight:

41.2 lbs. (18.7 kg)

PEAVEY ELECTRONICS CORPORATION LIMITED WARRANTY

EFFECTIVE DATE: JULY 1, 1998

What This Warranty Covers

Your Peavey Warranty covers defects in material and workmanship in Peavey products purchased and serviced in the U.S.A. and Canada.

What This Warranty Does Not Cover

The Warranty does not cover: (1) damage caused by accident, misuse, abuse, improper installation or operation, rental, product modification or neglect; (2) damage occurring during shipment; (3) damage caused by repair or service performed by persons not authorized by Peavey; (4) products on which the serial number has been altered, defaced or removed; (5) products not purchased from an Authorized Peavey Dealer.

Who This Warranty Protects

This Warranty protects only the original retail purchaser of the product.

How Long This Warranty Lasts

The Warranty begins on the date of purchase by the original retail purchaser. The duration of the Warranty is as follows:

Product Category	Duration
Guitars/Basses, Amplifiers, Pre-Amplifiers, Mixers, Electronic Crossovers and Equalizers	2 years *(+ 3 years)
Drums	2 years *(+ 1 year)
Enclosures	3 years *(+ 2 years)
Digital Effect Devices and Keyboard and MIDI Controllers	1 year *(+ 1 year)
Microphones	2 years
Speaker Components (incl. speakers, baskets, drivers, diaphragm replacement kits and passive crossovers) and all Accessories	1 year
Tubes and Meters	90 days

[*Denotes additional warranty period applicable if optional Warranty Registration Card is completed and returned to Peavey by original retail purchaser within 90 days of purchase.]

What Peavey Will Do

We will repair or replace (at Peavey's discretion) products covered by warranty at no charge for labor or materials. If the product or component must be shipped to Peavey for warranty service, the consumer must pay initial shipping charges. If the repairs are covered by warranty, Peavey will pay the return shipping charges.

How To Get Warranty Service

- (1) Take the defective item and your sales receipt or other proof of date of purchase to your Authorized Peavey Dealer or Authorized Peavey Service Center. OR
- (2) Ship the defective item, prepaid, to Peavey Electronics Corporation, International Service Center, 412 Highway 11 & 80 East, Meridian, MS 39301 or Peavey Canada Ltd., 95 Shields Court, Markham, Ontario, Canada L3R 9T5. Include a detailed description of the problem, together with a copy of your sales receipt or other proof of date of purchase as evidence of warranty coverage. Also provide a complete return address.

Limitation of Implied Warranties

ANY IMPLIED WARRANTIES, INCLUDING WARRANTIES OF MERCHANTABILITY AND FITNESS FOR A PARTICULAR PURPOSE, ARE LIMITED IN DURATION TO THE LENGTH OF THIS WARRANTY.

Some states do not allow limitations on how long an implied warranty lasts, so the above limitation may not apply to you.

Exclusions of Damages

PEAVEY'S LIABILITY FOR ANY DEFECTIVE PRODUCT IS LIMITED TO THE REPAIR OR REPLACEMENT OF THE PRODUCT, AT PEAVEY'S OPTION. IF WE ELECT TO REPLACE THE PRODUCT, THE REPLACEMENT MAY BE A RECONDITIONED UNIT. PEAVEY SHALL NOT BE LIABLE FOR DAMAGES BASED ON INCONVENIENCE, LOSS OF USE, LOST PROFITS, LOST SAVINGS, DAMAGE TO ANY OTHER EQUIPMENT OR OTHER ITEMS AT THE SITE OF USE, OR ANY OTHER DAMAGES WHETHER INCIDENTAL, CONSEQUENTIAL OR OTHERWISE, EVEN IF PEAVEY HAS BEEN ADVISED OF THE POSSIBILITY OF SUCH DAMAGES.

Some states do not allow the exclusion or limitation of incidental or consequential damages, so the above limitation or exclusion may not apply to you.

This Warranty gives you specific legal rights, and you may also have other rights which vary from state to state.

If you have any questions about this warranty or service received or if you need assistance in locating an Authorized Service Center, please contact the Peavey International Service Center at (601) 483-5365 / Peavey Canada Ltd. at (905) 475-2578.

FEATURES AND SPECIFICATIONS SUBJECT TO CHANGE WITHOUT NOTICE.



LISTEN TO THIS™

Features and specifications subject to change without notice.

Peavey Electronics Corporation • 711 A Street • Meridian, MS 39301

(601) 483-5365 • FAX (601) 486-1278 • www.peavey.com



80304908